

Digital servoproportional directional valves sleeve execution

direct, with on-board driver, LVDT transducer and zero spool overlap with fail safe

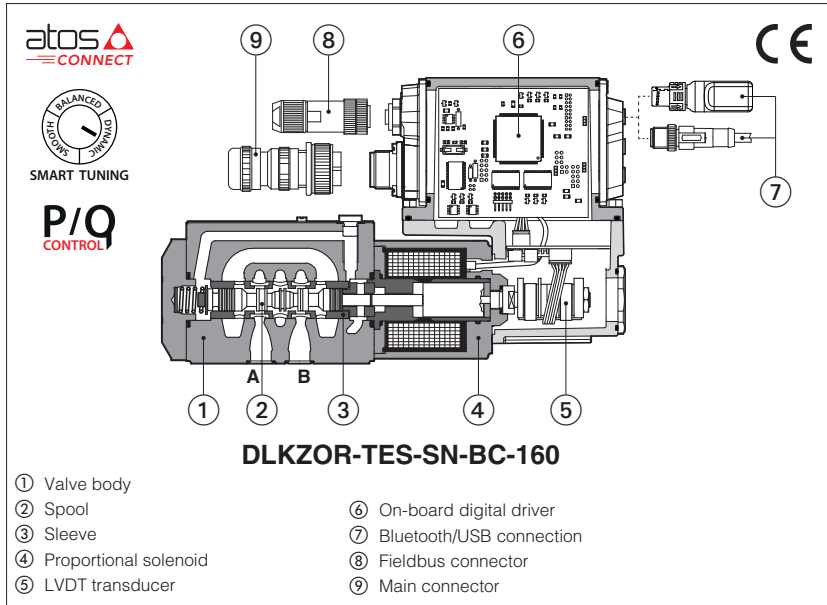

DLHZO-TEB, DLHZO-TES DLKZOR-TEB, DLKZOR-TES

Digital servoproportional directional valves, direct, in sleeve execution with LVDT position transducer and zero spool overlap for best performances in any position closed loop control.

TEB basic execution with analog reference signal or IO-Link interface for digital reference signals, valve settings, and real-time diagnostics.

TES full execution which includes also optional alternated p/Q controls and fieldbus interfaces for digital reference signals, valve settings, and real-time diagnostics.

Bluetooth/USB connection is always present for valve settings via mobile App and Atos PC software.

Digital TEZ version (see tech. table FS610) integrates on-board driver and axis card, while TEB-SN-NP and TES versions can be used in combination with Z-BM-KZ off-board axis card (see tech. table GS340).

DLHZO:	DLKZOR:
Size: 06 - ISO 4401	Size: 10 - ISO 4401
Max flow: 70 l/min	Max flow: 130 l/min
Max pressure: 350 bar	Max pressure: 315 bar

1 MODEL CODE

DLHZO	-	TES	-	SN	-	NP	-	0	40	-	L	7	3	/	*	/	*	/	*	/	*
--------------	---	------------	---	-----------	---	-----------	---	----------	-----------	---	----------	----------	----------	---	---	---	---	---	---	---	---

DLHZO = size 06
DLKZOR = size 10

TEB = basic on-board digital driver
TES = full on-board digital driver

Alternated p/Q controls, see section 8:
SN = none
 Only for **TES**:
SP = pressure control (1 pressure transducer)
SF = force control (2 pressure transducers)
SL = force control (1 load cell)

IO-Link interface, only for **TEB**, see section 6:
NP = Not present **IL** = IO-Link

Fieldbus interfaces, only for **TES**, see section 7:
NP = Not present **EW** = POWERLINK
BC = CANopen **EI** = EtherNet/IP
BP = PROFIBUS DP **EP** = PROFINET RT/IRT
EH = EtherCAT

Valve size ISO 4401: **0** = 06 **1** = 10

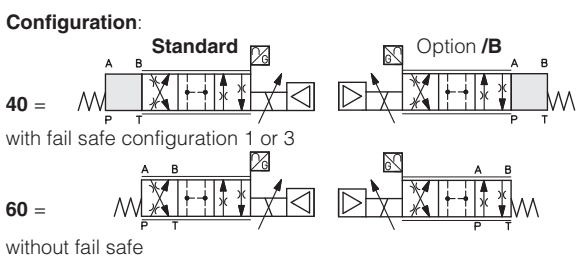

Spool type, regulating characteristics, see section 15:
L = linear **V** = progressive **T** = not linear (1)
D = differential-linear (1) **DT** = differential-not linear (1)
 P-A = Q, B-T = Q/2 P-A = Q, B-T = Q/2
 P-B = Q/2, A-T = Q P-B = Q/2, A-T = Q

(1) Only for configuration 40

Seals material, see section 14:
 - = NBR
PE = FKM
BT = NBR low temperature

Safety options TÜV certified - only for **TES (2)**:
U = safe double power supply
K = safe on/off signals
 See section 10



Bluetooth option (2), see section 4:
T = Bluetooth adapter supplied with the valve

Hydraulic options (2):
B = solenoid with on-board digital driver and LVDT transducer at side of port A
Y = external drain

Electronic options (2), not available for **TEB-SN-IL**:
C = current feedback for pressure transducer 4÷20mA (only for **TES-SP, SF, SL**)
F = fault signal
I = current reference input and monitor 4÷20mA
Q = enable signal
Z = double power supply (only for **TES**), enable, fault and monitor signals - 12 pin connector

Fail safe configuration, see section 16:



Note: select 1 for configuration 60 even without fail safe

Spool size: 0(L) 1(L) 1(V) 3(L) 3(T) 3(V) 5(L,T) 7(L,T,V,D,DT)

DLHZO =	4	7	12	14	-	20	28	40
DLKZOR =	-	-	-	60	60	-	-	100

Nominal flow (l/min) at Δp 70bar P-T (see section 12)

(2) For possible combined options, see section 19

2 GENERAL NOTES

Atos digital proportionals valves are CE marked according to the applicable directives (e.g. Immunity and Emission EMC Directive). Installation, wirings and start-up procedures must be performed according to the general prescriptions shown in tech table **FS900** and in the user manuals included in the E-SW-SETUP programming software.

3 VALVE SETTINGS AND PROGRAMMING TOOLS - see tech. table **GS500**

3.1 Atos CONNECT mobile App

Free downloadable App for smartphones and tablets which allows quick access to valve main functional parameters and basic diagnostic information via Bluetooth, thus avoiding physical cable connection and significantly reducing commissioning time. Atos CONNECT supports Atos digital valve drivers equipped with E-A-BTH adapter or with built-in Bluetooth. It does not support valves with p/Q control or axis controls.



3.2 E-SW-SETUP PC software

Free downloadable software for PC allows to set all valve functional parameters and to access complete diagnostic information of digital valve drivers via Bluetooth/USB service port. Atos E-SW-SETUP PC software supports all Atos digital valve drivers and it is available at www.atos.com in MyAtos area.



WARNING: drivers USB port is not isolated! For E-C-SB-USB/M12 cable, the use of E-A-SB-USB/OPT isolator adapter is highly recommended for PC protection

Bluetooth or USB connection

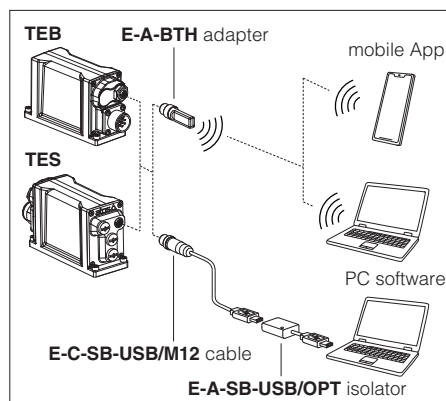

4 BLUETOOTH OPTION - see tech. table **GS500**

T option adds Bluetooth® connectivity to Atos valve drivers thanks to E-A-BTH adapter, which can be left permanently installed on-board, to allow the Bluetooth connection with the valve drivers at any time. E-A-BTH adapter can also be purchased separately and used to connect with any supported Atos digital product.

Bluetooth connection to the valve can be protected against unauthorised access by setting a personal password. The adapter leds visually indicates the status of valve driver and Bluetooth connection.



WARNING: for the list of countries where the Bluetooth adapter has been approved, see tech. table **GS500**
T option is not available for the Indian market, so the Bluetooth adapter must be ordered separately.

5 SMART TUNING

Smart tuning allows to adjust the valve dynamic response in order to match different performance requirements.

The valve is provided with 3 factory settings for the spool control:

- **dynamic** fast response time and high sensitivity for best dynamic performances. Default factory setting for directional valves
- **balanced** average response time and sensitivity suitable for major applications
- **smooth** attenuated response time and sensitivity to improve control stability in critical applications or in environments with electrical disturbances

Smart tuning setting can be switched from Dynamic (default) to Balanced or Smooth via software or fieldbus; if requested, performances can be further customized directly tuning each single control parameter. For details consult related manuals E-MAN-RI-* and Quickstart, see section [27](#).

For Response time and Bode diagrams see section [15](#).

6 IO-LINK - only for **TEB**, see tech. table **GS520**

IO-Link allows low cost digital communication between the valve and machine central unit. The valve is directly connected to a port of an IO-Link master (point-to-point connection) via low-cost unshielded cables for digital reference, diagnostic and settings. The IO-Link master works as a hub exchanging this information with the machine central unit via fieldbus.

7 FIELDBUS - only for **TES**, see tech. table **GS510**

Fieldbus allows valve direct communication with machine control unit for digital reference, valve diagnostics and settings. These execution allow to operate the valves through fieldbus or analog signals available on the main connector.

8 ALTERNATED p/Q CONTROLS - only for **TES**, see tech. table **FS500**

S* options add the closed loop control of pressure (**SP**) or force (**SF** and **SL**) to the basic functions of proportional directional valves flow regulation. A dedicated algorithm alternates pressure (force) depending on the actual hydraulic system conditions.

An additional connector is available for transducers to be interfaced to the valve's driver (1 pressure transducer for SP, 2 pressure transducers for SF or 1 load cell for SL). The alternated pressure control (SP) is possible only for specific installation conditions.

Main 12 pin connector is the same as /Z option plus two analog signals specific for the pressure (force) control.

9 AXIS CONTROLLER - see tech. table **FS610**

Digital servoproportional with on-board electronics **TEZ** include valve's driver plus axis controller, performing position closed loop of any hydraulic actuator equipped with analog, encoder or SSI position transducer. **S*** option add alternated p/Q control to the basic position ones.

Atos also supplies complete servoactuators integrating servocylinder, digital servoproportional valve and axis controller, fully assembled and tested. For more information consult Atos Technical Office.

10 SAFETY OPTIONS - only for **TES**

Atos range of proportional directional valves, provides functional safety options **/U** and **/K**, designed to accomplish a safety function, intended to reduce the risk in process control systems.

They are TÜV certified in compliance to IEC 61508 up to SIL 3 and ISO 13849 up to category 4, PL e



Safe double power supply, option **/U**: the driver has separate power supplies for logic and solenoids. The safe condition is reached by cutting the electrical supply to solenoids, while electronics remains active for monitoring functions and fieldbus communication, see tech table **FY100**

Safety function via on/off signals, option **/K**: upon a disable command, the driver checks the spool position and it provides an on/off acknowledgement signal only when the valve is in safe condition, see tech table **FY200**

11 GENERAL CHARACTERISTICS

Assembly position	Any position
Subplate surface finishing to ISO 4401	Acceptable roughness index: Ra ≤0,8, recommended Ra 0,4 – Flatness ratio 0,01/100
MTTFd valves according to EN ISO 13849	150 years, for further details see technical table P007
Ambient temperature range	Standard = -20°C ÷ +60°C /PE option = -20°C ÷ +60°C /BT option = -40°C ÷ +60°C
Storage temperature range	Standard = -20°C ÷ +70°C /PE option = -20°C ÷ +70°C /BT option = -40°C ÷ +70°C
Surface protection	Zinc coating with black passivation, galvanic treatment (driver housing)
Corrosion resistance	Salt spray test (EN ISO 9227) > 200 h
Vibration resistance	See technical table G004
Compliance	CE according to EMC directive 2014/30/EU (Immunity: EN 61000-6-2; Emission: EN 61000-6-3) RoHS Directive 2011/65/EU as last update by 2015/863/EU REACH Regulation (EC) n°1907/2006

12 HYDRAULIC CHARACTERISTICS - based on mineral oil ISO VG 46 at 50 °C

Valve model	DLHZO											DLKZOR							
	ports P, A, B = 350; T = 210 (250 with external drain /Y) Y = 10											ports P, A, B = 315; T = 210 (250 with external drain /Y) Y = 10							
Pressure limits [bar]	L0	L1	V1	L3	V3	L5	T5	L7	T7	V7	D7	DT7	L3	T3	L7	T7	V7	D7	DT7
Spool type and size																			
Nominal flow Δp P-T [l/min]																			
Δp= 30 bar	2,5	4,5	8	9	13	18		26			26÷13 (4)		40		60			60÷33 (4)	
Δp= 70 bar	4	7	12	14	20	28		40			40÷20 (4)		60		100			100÷50 (4)	
Max permissible flow	8	14	16	30	40	50		70			70÷40 (4)		110		130			130÷65 (4)	
Leakage (2) [cm³/min]	<100	<200	<100	<300	<150	<500	<200	<900	<200	<200	<700	<200	<1000	<400	<1500	<400	<400	<1200	<400
Response time (3) [ms]	≤ 10											≤ 15							
Hysteresis	≤ 0,1 [% of max regulation]																		
Repeatability	± 0,1 [% of max regulation]																		
Thermal drift	zero point displacement < 1% at ΔT = 40°C																		

(1) For different Δp, the max flow is in accordance to the diagrams in section 15.2

(2) Referred to spool in neutral position and 50°C oil temperature

(3) 0-100% step signal

(4) For spool type D7 and DT7 the flow value is referred to single path P-A (A-T) ÷ P-B (B-T) at Δp/2 per control edge

13 ELECTRICAL CHARACTERISTICS

Power supplies	Nominal : +24 VDC Rectified and filtered : VRMS = 20 ÷ 32 VMAX (ripple max 10 % VPP)				
Max power consumption	50 W				
Max. solenoid current	DLHZO = 2,6 A		DLKZOR = 3 A		
Coil resistance R at 20°C	DLHZO = 3 ÷ 3,3 Ω		DLKZOR = 2,2 ÷ 2,4 Ω		
Analog input signals	Voltage: range ±10 VDC (24 VMAX tolerant) Current: range ±20 mA			Input impedance: Ri > 50 kΩ Input impedance: Ri = 500 Ω	
Monitor outputs	Output range: voltage ±10 VDC @ max 5 mA current ±20 mA @ max 500 Ω load resistance				
Enable input	Range: 0 ÷ 5 VDC (OFF state), 9 ÷ 24 VDC (ON state), 5 ÷ 9 VDC (not accepted); Input impedance: Ri > 10 kΩ				
Fault output	Output range: 0 ÷ 24 VDC (ON state > [power supply - 2 V] ; OFF state < 1 V) @ max 50 mA; external negative voltage not allowed (e.g. due to inductive loads)				
Pressure/Force transducer power supply (only for SP, SF, SL)	+24VDC @ max 100 mA (E-ATR-8 see tech table GS465)				
Alarms	Solenoid not connected/short circuit, cable break with current reference signal, over/under temperature, valve spool transducer malfunctions, alarms history storage function				
Insulation class	H (180°) Due to the occurring surface temperatures of the solenoid coils, the European standards ISO 13732-1 and EN982 must be taken into account				
Protection degree to DIN EN60529	IP66 / IP67 with mating connectors				
Duty factor	Continuous rating (ED=100%)				
Tropicalization	Tropical coating on electronics PCB				
Additional characteristics	Short circuit protection of solenoid's current supply; 3 leds for diagnostic (only for TES); spool position control (SN) or pressure/force control (SP, SF, SL) by P.I.D. with rapid solenoid switching; protection against reverse polarity of power supply				
Communication interface	USB Atos ASCII coding	IO-Link Interface and System Specification 1.1.3	CANopen EN50325-4 + DS408	PROFIBUS DP EN50170-2/IEC61158	EtherCAT POWERLINK EtherNet/IP PROFINET IO RT/IRT IEC 61158
Communication physical layer	not insulated USB 2.0+USB OTG	SDCI class port B	optical insulated CAN ISO11898	optical insulated RS485	Fast Ethernet, insulated 100 Base TX
Recommended wiring cable	LIYCY shielded cables, see section 24				

Note: a maximum time of 800 ms (depending on communication type) has to be considered between the driver energizing with the 24 Vdc power supply and when the valve is ready to operate. During this time the current to the valve coils is switched to zero.

14 SEALS AND HYDRAULIC FLUIDS - for other fluids not included in below table, consult our technical office

Seals, recommended fluid temperature	NBR seals (standard) = -20°C ÷ +60°C, with HFC hydraulic fluids = -20°C ÷ +50°C FKM seals (/PE option) = -20°C ÷ +80°C NBR low temp. seals (/BT option) = -40°C ÷ +60°C, with HFC hydraulic fluids = -20°C ÷ +50°C		
Recommended viscosity	20 ÷ 100 mm ² /s - max allowed range 15 ÷ 380 mm ² /s		
Max fluid contamination level	normal operation	ISO4406 class 18/16/13 NAS1638 class 7	see also filter section at www.atos.com or KTF catalog
	longer life	ISO4406 class 16/14/11 NAS1638 class 5	
Hydraulic fluid	Suitable seals type	Classification	Ref. Standard
Mineral oils	NBR, FKM, NBR low temp.	HL, HLP, HLPD, HVLP, HVLPD	DIN 51524
Flame resistant without water	FKM	HFDU, HFDR	ISO 12922
Flame resistant with water	NBR, NBR low temp.	HFC	

15 DIAGRAMS (based on mineral oil ISO VG 46 at 50 °C)

15.1 Regulation diagrams

- 1 = Linear spools L
- 2 = Differential - linear spool D7
- 3 = Differential non linear spool DT7
- 4 = Non linear spool T5 (only for DLHZO)
- 5 = Non linear spool T3 (only for DLKZOR) and T7
- 6 = Progressive spool V

T3, T5 and T7 spool types are specific for fine low flow control in the range from 0 to 60% (T5) and 0 to 40% (T3 and T7) of max spool stroke.

The non linear characteristics of the spool is compensated by the electronic driver, so the final valve regulation is resulting linear respect the reference signal (dotted line).

DT7 has the same characteristic of T7 but it is specific for applications with cylinders with area ratio 1:2

Note:
Hydraulic configuration vs. reference signal:

Standard:
Reference signal $\left. \begin{matrix} 0 \div +10 \text{ V} \\ 12 \div 20 \text{ mA} \end{matrix} \right\} P \rightarrow A / B \rightarrow T$

Reference signal $\left. \begin{matrix} 0 \div -10 \text{ V} \\ 12 \div 4 \text{ mA} \end{matrix} \right\} P \rightarrow B / A \rightarrow T$

option /B:
Reference signal $\left. \begin{matrix} 0 \div +10 \text{ V} \\ 12 \div 20 \text{ mA} \end{matrix} \right\} P \rightarrow B / A \rightarrow T$

Reference signal $\left. \begin{matrix} 0 \div -10 \text{ V} \\ 12 \div 4 \text{ mA} \end{matrix} \right\} P \rightarrow A / B \rightarrow T$

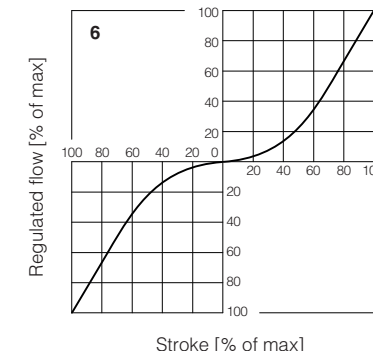
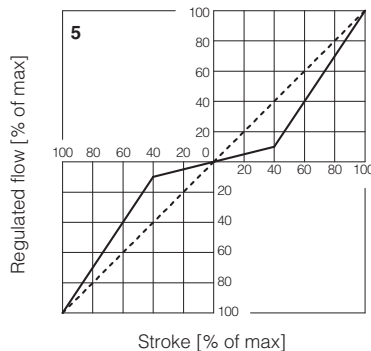
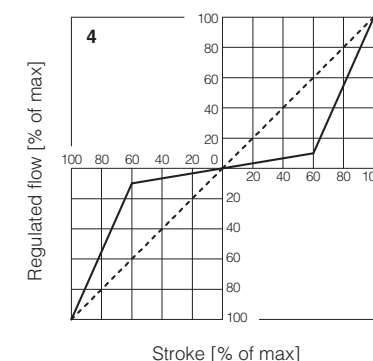
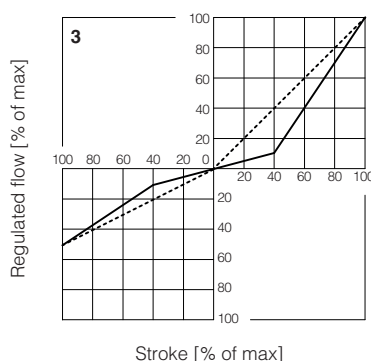
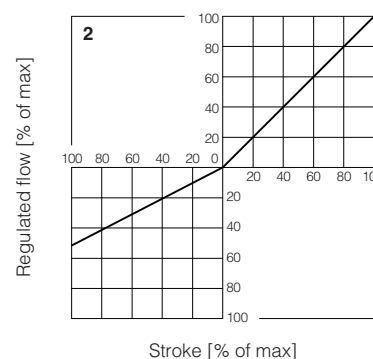
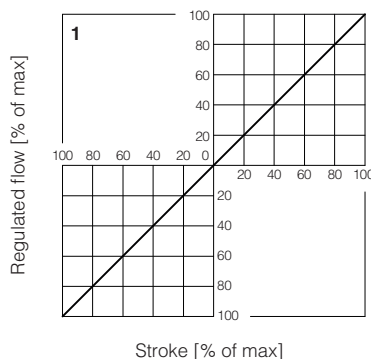

15.2 Flow / Δp diagrams

Stated at 100% of spool stroke

DLHZO:

- 1 = spool L7, T7, V7, D7, DT7
- 2 = spool L5, T5
- 3 = spool V3
- 4 = spool L3
- 5 = spool L1, V1
- 6 = spool L0

DLKZOR:

- 7 = spool L7, T7, V7, D7, DT7
- 8 = spool L3, T3

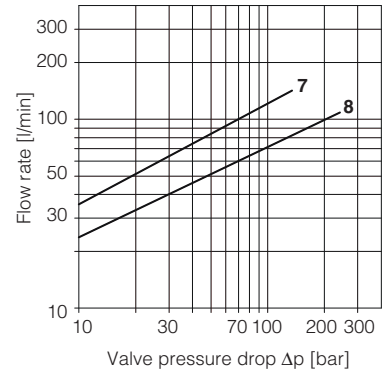
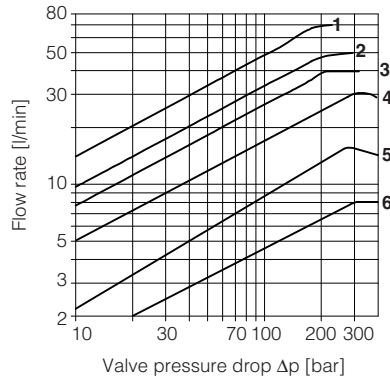

15.3 Pressure gain

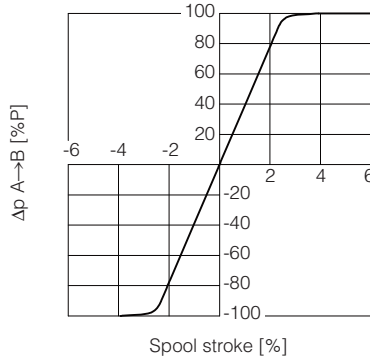
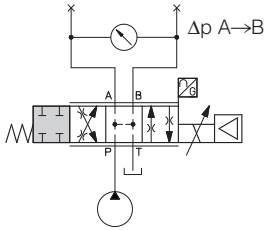

15.4 Response time

The response times in below diagrams are measured at different steps of the reference input signal. They have to be considered as average values.

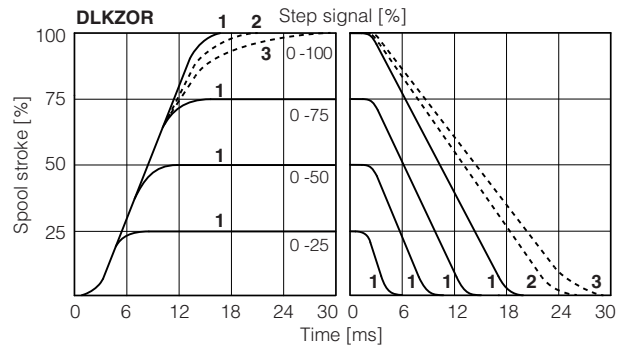
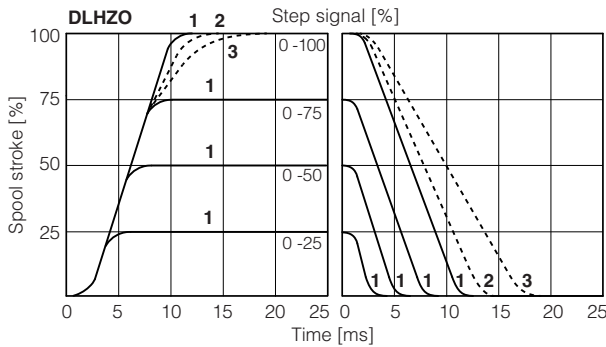

1 = dynamic 2 = balanced (*) 3 = smooth (*)

(*) Response time is represented only for 0-100% step; for intermediate steps, the response time increment of presets 2 (balanced) and 3 (smooth) with respect to the preset 1 (dynamic) is proportional to the step amplitude of the reference input signal

15.5 DLHZO Bode diagrams

Stated at nominal hydraulic conditions

± 5% nominal stroke:

- 1 = dynamic
- 2 = balanced
- 3 = smooth

± 100% nominal stroke:

- 4 = dynamic
- 5 = balanced
- 6 = smooth

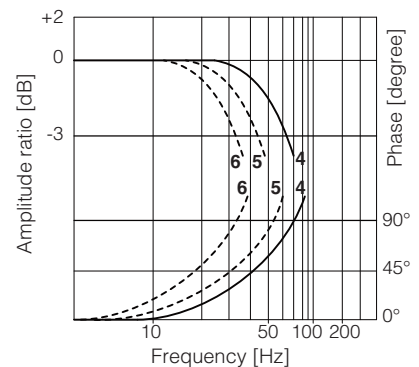
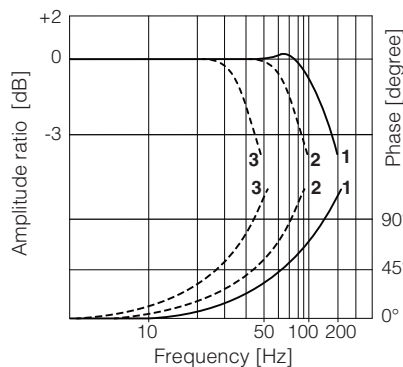

15.6 DLKZOR Bode diagrams

Stated at nominal hydraulic conditions

± 5% nominal stroke:



- 1 = dynamic
- 2 = balanced
- 3 = smooth

± 100% nominal stroke:

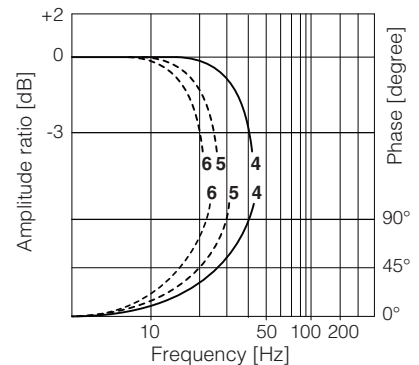
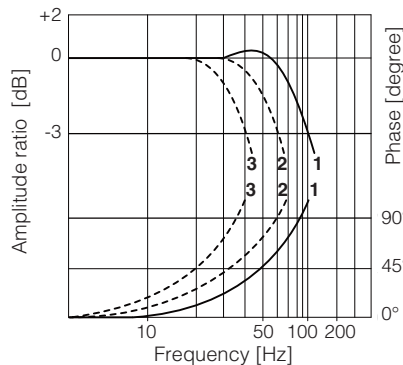
- 4 = dynamic
- 5 = balanced
- 6 = smooth

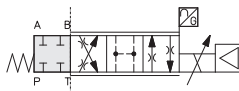

16 FAIL SAFE POSITION

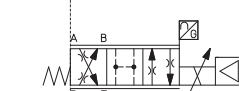
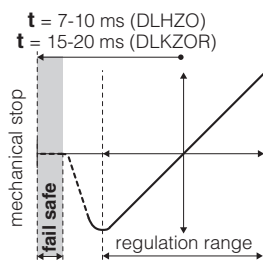
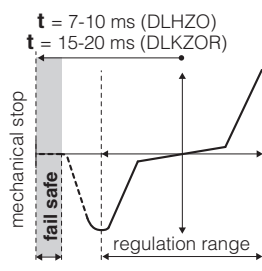
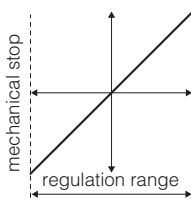
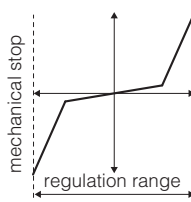
CONFIGURATION	LINEAR	NOT LINEAR		
 <p>fail safe 1</p>  <p>fail safe 3</p>  <p>without fail safe</p>	 <p>$t = 7-10$ ms (DLHZO) $t = 15-20$ ms (DLKZOR)</p> <p>mechanical stop</p> <p>fail safe</p> <p>regulation range</p>	 <p>$t = 7-10$ ms (DLHZO) $t = 15-20$ ms (DLKZOR)</p> <p>mechanical stop</p> <p>fail safe</p> <p>regulation range</p>		
	t = time required by the valve to switch from central to fail safe position at the power switch-off, with pressure 0 to 100 bar			
	 <p>mechanical stop</p> <p>regulation range</p>	 <p>mechanical stop</p> <p>regulation range</p>		
Fail safe connections	P → A	P → B	A → T	B → T
Leakage [cm ³ /min] at P = 100 bar (1)	Fail safe 1: 50	Fail safe 1: 70	Fail safe 1: 70	Fail safe 1: 50
	Fail safe 3: 50	Fail safe 3: 70	Fail safe 3: -	Fail safe 3: -
Flow [l/min] (2)	DLHZO	-	15÷30	10÷20
	DLKZOR	-	40÷60	25÷40

(1) Referred to spool in fail safe position and 50°C oil temperature (2) Referred to spool in fail safe position at $\Delta p = 35$ bar per edge

17 HYDRAULIC OPTIONS

B = Solenoid, on-board digital driver and position transducer at side of port A of the main stage. For hydraulic configuration vs reference signal, see 15.1
Y = This option is mandatory if the pressure in port T exceeds 210 bar.

18 ELECTRONIC OPTIONS - not available for **TEB-SN-IL**

- F** = This option permits to monitor the eventual fault condition of the driver, as for example the solenoid short circuit/not connected, reference signal cable broken for option /I, spool position transducer broken, etc. - see 20.9 for signal specifications.
- I** = This option provides 4 ÷ 20 mA current reference and monitor signals, instead of the standard ± 10 VDC.
 Input signal can be reconfigured via software selecting between voltage and current, within a maximum range of ± 10 VDC or ± 20 mA.
 It is normally used in case of long distance between the machine control unit and the valve or where the reference signal can be affected by electrical noise; the valve functioning is disabled in case of reference signal cable breakage.
- Q** = This option permits to inhibit the valve function without removing the power supply to the driver. Upon disable command the current to the solenoid is zeroed and the valve's spool moves to rest position.
 The option /Q is suggested for all cases where the valve has to be frequently inhibited during the machine cycle – see 20.7 for signal specifications.
- Z** = This option provides, on the 12 pin main connector, the following additional features:
Fault output signal - see above option /F
Enable input signal - see above option /Q
Repeat enable output signal - only for **TEB-SN-NP** (see 20.8)
Power supply for driver's logics and communication - only for **TES** (see 20.2)
- C** = This option is available to connect pressure (force) transducers with 4 ÷ 20 mA current output signal, instead of the standard ± 10 VDC.
 Input signal can be reconfigured via software selecting between voltage and current, within a maximum range of ± 10 VDC or ± 20 mA.

19 POSSIBLE COMBINED OPTIONS

Standard versions for **TEB-SN-NP and **TES-SN**:**

/BF, /BFI, /BFIY, /BFY, /BI, /BIQ, /BIQY, /BIY, /BIYZ, /BIZ, /BQ,
 /BQY, /BY, /BYZ, /BZ,
 /FI, /FIY, /FY,
 /IQ, /IQY, /IY, /IYZ, /IZ,
 /QY, /YZ

Standard versions for **TEB-SN-IL:**

/BY

Standard versions for **TES-SP, SF, SL:**

/BC, /BCI, /BCIY, /BCY, /BI, /BIY, /BY,
 /CI, /CIY, /CY,
 /IY

Safety certified versions for **TES-SN:**

/BI/U, /BIY/U, /B/U, /BY/U, /I/U, /IY/U, /Y/U
 /BI/K, /BIY/K, /B/K, /BY/K, /I/K, /IY/K, /Y/K

Safety certified versions for **TES-SP, SF, SL:**

/BC/U, /BCI/U, /BCIY/U, /BCY/U, /BI/U, /BIY/U, /B/U, /BY/U,
 /C/U, /CI/U, /CIY/U, /CY/U, /I/U, /IY/U, /Y/U
 /BC/K, /BCI/K, /BCIY/K, /BCY/K, /BI/K, /BIY/K, /B/K, /BY/K,
 /C/K, /CI/K, /CIY/K, /CY/K, /I/K, /IY/K, /Y/K

Note: /T Bluetooth adapter option can be combined with all other options

20 POWER SUPPLY AND SIGNALS SPECIFICATIONS

Generic electrical output signals of the valve (e.g. fault or monitor signals) must not be directly used to activate safety functions, like to switch-ON/OFF the machine's safety components, as prescribed by the European standards (Safety requirements of fluid technology systems and components-hydraulics, ISO 4413).

For **TEB-SN-IL** signals see section 21

For certified safety options: **/U** see tech. table **FY100** and **/K** see tech. table **FY200**

20.1 Power supply (V+ and V0)

The power supply must be appropriately stabilized or rectified and filtered: apply at least a 10000 μ F/40 V capacitance to single phase rectifiers or a 4700 μ F/40 V capacitance to three phase rectifiers. In case of separate power supply see 20.2.



A safety fuse is required in series to each power supply: 2,5 A time lag fuse.

20.2 Power supply for driver's logic and communication (VL+ and VL0) - only for TES with /Z option and for TES-SP, SF, SL with fieldbus

The power supply for driver's logic and communication must be appropriately stabilized or rectified and filtered: apply at least a 10000 μ F/40 V capacitance to single phase rectifiers or a 4700 μ F/40 V capacitance to three phase rectifiers.

The separate power supply for driver's logic on pin 9 and 10, allow to remove solenoid power supply from pin 1 and 2 maintaining active the diagnostics, USB and fieldbus communications.



A safety fuse is required in series to each driver's logic and communication power supply: 500 mA fast fuse.

20.3 Flow reference input signal (Q_INPUT+)

The driver controls in closed loop the valve spool position proportionally to the external reference input signal.

Reference input signal is factory preset according to selected valve code, defaults are ± 10 VDC for standard and $4 \div 20$ mA for /I option.

Input signal can be reconfigured via software selecting between voltage and current, within a maximum range of ± 10 VDC or ± 20 mA.

Drivers with fieldbus interface can be software set to receive reference signal directly from the machine control unit (fieldbus reference).

Analog reference input signal can be used as on-off commands with input range $0 \div 24$ VDC.

20.4 Pressure or force reference input signal (F_INPUT+) - only for TES-SP, SF, SL

Functionality of F_INPUT+ signal (pin 7), is used as reference for the driver pressure/force closed loop (see tech. table **FS500**).

Reference input signal is factory preset according to selected valve code, defaults are ± 10 VDC for standard and $4 \div 20$ mA for /I option.

Input signal can be reconfigured via software selecting between voltage and current, within a maximum range of ± 10 VDC or ± 20 mA.

Drivers with fieldbus interface can be software set to receive reference signal directly by the machine control unit (fieldbus reference).

Analog reference input signal can be used as on-off commands with input range $0 \div 24$ VDC.

20.5 Flow monitor output signal (Q_MONITOR) - not for /F

The driver generates an analog output signal proportional to the actual spool position of the valve; the monitor output signal can be software set to show other signals available in the driver (e.g. analog reference, fieldbus reference, pilot spool position).

Monitor output signal is factory preset according to selected valve code, defaults are ± 10 VDC for standard and $4 \div 20$ mA for /I option.

Output signal can be reconfigured via software selecting between voltage and current, within a maximum range of ± 10 VDC or ± 20 mA.

20.6 Pressure or force monitor output signal (F_MONITOR) - only for TES-SP, SF, SL

The driver generates an analog output signal proportional to alternated pressure/force control; the monitor output signal can be software set to show other signals available in the driver (e.g. analog reference, force reference).

Monitor output signal is factory preset according to selected valve code, defaults are ± 10 VDC for standard and $4 \div 20$ mA for /I option.

Output signal can be reconfigured via software selecting between voltage and current, within a maximum range of ± 10 VDC or ± 20 mA.

20.7 Enable input signal (ENABLE) - not for standard and /F

To enable the driver, supply a 24 VDC on pin 3 (pin C): Enable input signal allows to enable/disable the current supply to the solenoid, without removing the electrical power supply to the driver; it is used to active the communication and the other driver functions when the valve must be disabled for safety reasons. This condition **does not comply** with norms IEC 61508 and ISO 13849.

Enable input signal can be used as generic digital input by software selection.

20.8 Repeat enable output signal (R_ENABLE) - only for TEB-SN-NP with /Z option

Repeat enable is used as output repeater signal of enable input signal (see 20.7).

20.9 Fault output signal (FAULT) - not for standard and /Q

Fault output signal indicates fault conditions of the driver (solenoid short circuits/not connected, reference signal cable broken for $4 \div 20$ mA input, spool position transducer cable broken, etc.). Fault presence corresponds to 0 VDC, normal working corresponds to 24 VDC.

Fault status is not affected by the Enable input signal. Fault output signal can be used as digital output by software selection.

20.10 Remote pressure/force transducer input signal - only for TES-SP, SF, SL

Analog remote pressure transducers or load cell can be directly connected to the driver (see 22.5).

Analog input signal is factory preset according to selected valve code, defaults are ± 10 VDC for standard and $4 \div 20$ mA for /C option.

Input signal can be reconfigured via software selecting between voltage and current, within a maximum range of ± 10 VDC or ± 20 mA.

Refer to pressure/force transducer characteristics to select the transducer type according to specific application requirements (see tech table **FS500**).

20.11 Multiple PID selection (D_IN0 and D_IN1) - only NP execution for TES-SP, SF, SL

Two on-off input signals are available on the main connector to select one of the four pressure (force) PID parameters setting, stored into the driver.

Switching the active setting of pressure PID during the machine cycle allows to optimize the system dynamic response in different hydraulic working conditions (volume, flow, etc.).

Supply a 24 VDC or a 0 VDC on pin 9 and/or pin 10, to select one of the PID settings as indicated by binary code table at side. Gray code can be selected by software.

PID SET SELECTION				
PIN	SET 1	SET 2	SET 3	SET 4
9	0	24 Vdc	0	24 Vdc
10	0	0	24 Vdc	24 Vdc

21 IO-LINK SIGNALS SPECIFICATIONS - only for TEB-SN-IL

21.1 Power supply for IO-Link communication (L+ and L-)

The IO-Link master provides dedicated 24 Vdc power supply for IO-Link communication.

Maximum power consumption: 2 W

Internal electrical isolation of power L+, L- from P24, N24

21.2 Power supply for driver's logic and valve regulation (P24 and N24)

The IO-Link master provides dedicated 24 Vdc power supply for valve regulation, logics and diagnostics.

Maximum power consumption: 50 W

Internal electrical isolation of power P24, N24 from L+, L-

21.3 IO-Link data line (C/Q)

C/Q signal is used to establish communication between IO-Link master and valve.

22 ELECTRONIC CONNECTIONS

For electronic connection of certified safety options /U see tech. table **FY100** and /K see tech. table **FY200**

22.1 Main connector signals - 7 pin (A1) Standard, /Q and /F options

PIN	Standard	/Q	/F	TECHNICAL SPECIFICATIONS	NOTES
A	V+			Power supply 24 Vdc	Input - power supply
B	V0			Power supply 0 Vdc	Gnd - power supply
C	AGND		AGND	Analog ground	Gnd - analog signal
		ENABLE		Enable (24 Vdc) or disable (0 Vdc) the valve, referred to V0	Input - on/off signal
D	Q_INPUT+			Flow reference input signal: ± 10 Vdc / ± 20 mA maximum range Defaults are ± 10 Vdc for standard and $4 \div 20$ mA for /I option	Input - analog signal Software selectable
E	INPUT-			Negative reference input signal for Q_INPUT+	Input - analog signal
F	Q_MONITOR referred to:			Flow monitor output signal: ± 10 Vdc / ± 20 mA maximum range Defaults are ± 10 Vdc for standard and $4 \div 20$ mA for /I option	Output - analog signal Software selectable
	AGND	V0			
G			FAULT	Fault (0 Vdc) or normal working (24 Vdc)	Output - on/off signal
	EARTH				

22.2 Main connector signals - 12 pin (A2) /Z option and TES-SP, SF, SL

PIN	TEB-SN /Z	TES-SN /Z	TES-SP, SF, SL Fieldbus NP		TECHNICAL SPECIFICATIONS	NOTES
1	V+				Power supply 24 Vdc	Input - power supply
2	V0				Power supply 0 Vdc	Gnd - power supply
3	ENABLE referred to: V0				Enable (24 Vdc) or disable (0 Vdc) the valve	Input - on/off signal
		VLO	VLO	V0		
4	Q_INPUT+				Flow reference input signal: ± 10 Vdc / ± 20 mA maximum range Defaults are ± 10 Vdc for standard and $4 \div 20$ mA for /I option	Input - analog signal Software selectable
5	INPUT-				Negative reference input signal for Q_INPUT+ and F_INPUT+	Input - analog signal
6	Q_MONITOR referred to:				Flow monitor output signal: ± 10 Vdc / ± 20 mA maximum range Defaults are ± 10 Vdc for standard and $4 \div 20$ mA for /I option	Output - analog signal Software selectable
	AGND	VLO	VLO	V0		
7	AGND				Analog ground	Gnd - analog signal
		NC			Do not connect	
8	R_ENABLE				Repeat enable, output repeater signal of enable input, referred to V0	Output - on/off signal
		NC			Do not connect	
9	F_MONITOR referred to: VLO				Pressure/Force monitor output signal: ± 10 Vdc / ± 20 mA maximum range Defaults are ± 10 Vdc for standard and $4 \div 20$ mA for /I option	Output - analog signal Software selectable
			VLO	V0		
10	NC				Do not connect	
		VL+			Power supply 24 Vdc for driver's logic and communication	Input - power supply
11	D_IN0				Multiple pressure/force PID selection, referred to V0	Input - on/off signal
		NC			Do not connect	
12	VLO				Power supply 0 Vdc for driver's logic and communication	Gnd - power supply
				D_IN1	Multiple pressure/force PID selection (not available for SF), referred to V0	Input - on/off signal
PE	FAULT referred to: V0				Fault (0 Vdc) or normal working (24 Vdc)	Output - on/off signal
		VLO	VLO	V0		
EARTH					Internally connected to the driver housing	

Note: do not disconnect VLO before VL+ when the driver is connected to PC USB port

22.3 IO-Link connector signals - M12 - 5 pin - Coding A, port class B (A) only for **TEB-SN-IL**

PIN	SIGNAL	TECHNICAL SPECIFICATIONS	NOTES
1	L+	Power supply 24 Vdc for IO-Link communication	Input - power supply
2	P24	Power supply 24 Vdc for valve regulation, logics and diagnostics	Input - power supply
3	L-	Power supply 0 Vdc for IO-Link communication	Gnd - power supply
4	C/Q	IO-Link data line	Input / Output - signal
5	N24	Power supply 0 Vdc for valve regulation, logics and diagnostics	Gnd - power supply

Note: L+, L- and P24, N24 are electrically isolated

22.4 Communications connectors (B) - (C)

(B) **USB connector - M12 - 5 pin** always present

PIN	SIGNAL	TECHNICAL SPECIFICATION (1)
1	+5V_USB	Power supply
2	ID	Identification
3	GND_USB	Signal zero data line
4	D-	Data line -
5	D+	Data line +

(C1) (C2) **BC fieldbus execution, connector - M12 - 5 pin**

PIN	SIGNAL	TECHNICAL SPECIFICATION (1)
1	CAN_SHLD	Shield
2	not used	(C1) - (C2) pass-through connection (2)
3	CAN_GND	Signal zero data line
4	CAN_H	Bus line (high)
5	CAN_L	Bus line (low)

(C1) (C2) **BP fieldbus execution, connector - M12 - 5 pin**

PIN	SIGNAL	TECHNICAL SPECIFICATION (1)
1	+5V	Termination supply signal
2	LINE-A	Bus line (high)
3	DGND	Data line and termination signal zero
4	LINE-B	Bus line (low)
5	SHIELD	

(C1) (C2) **EH, EW, EI, EP fieldbus execution, connector - M12 - 4 pin**

PIN	SIGNAL	TECHNICAL SPECIFICATION (1)
1	TX+	Transmitter
2	RX+	Receiver
3	TX-	Transmitter
4	RX-	Receiver
Housing	SHIELD	

(1) Shield connection on connector's housing is recommended

(2) Pin 2 can be fed with external +5V supply of CAN interface

22.5 Remote pressure/force transducer connector - M12 - 5 pin - only for SP, SF, SL (D)

PIN	SIGNAL	TECHNICAL SPECIFICATION	NOTES	(D1) SP, SL - Single transducer (1)		(D2) SF - Double transducers (1)	
				Voltage	Current	Voltage	Current
1	VF +24V	Power supply +24Vdc	Output - power supply	Connect	Connect	Connect	Connect
2	TR1	1st signal transducer: ±10 Vdc / ±20 mA maximum range	Input - analog signal Software selectable	Connect	Connect	Connect	Connect
3	AGND	Common gnd for transducer power and signals	Common gnd	Connect	/	Connect	/
4	TR2	2nd signal transducer: ±10 Vdc / ±20 mA maximum range	Input - analog signal Software selectable	/	/	Connect	Connect
5	NC	Not connect		/	/	/	/

(1) Single/double transducer configuration is software selectable

Remote pressure transducers connection - example

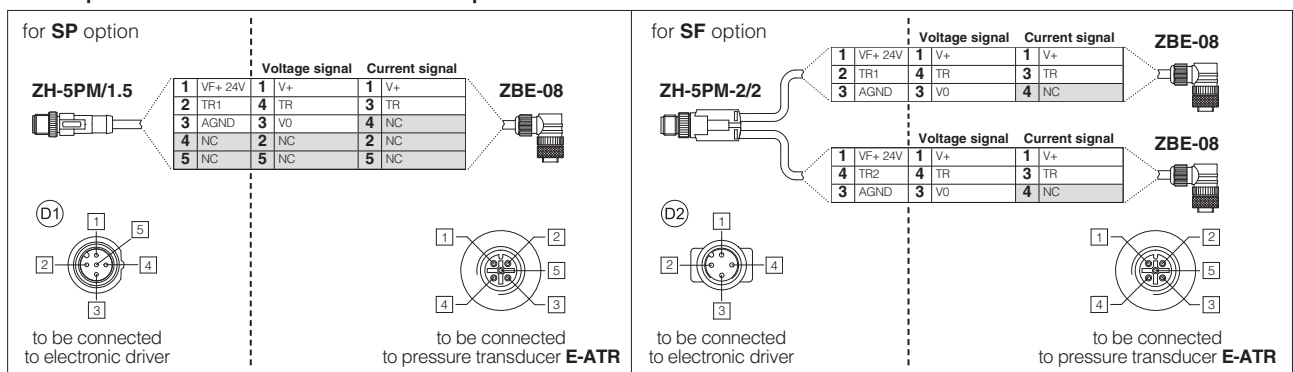

Note: pin layout always referred to driver's view

22.6 TEB-SN-NP connections layout

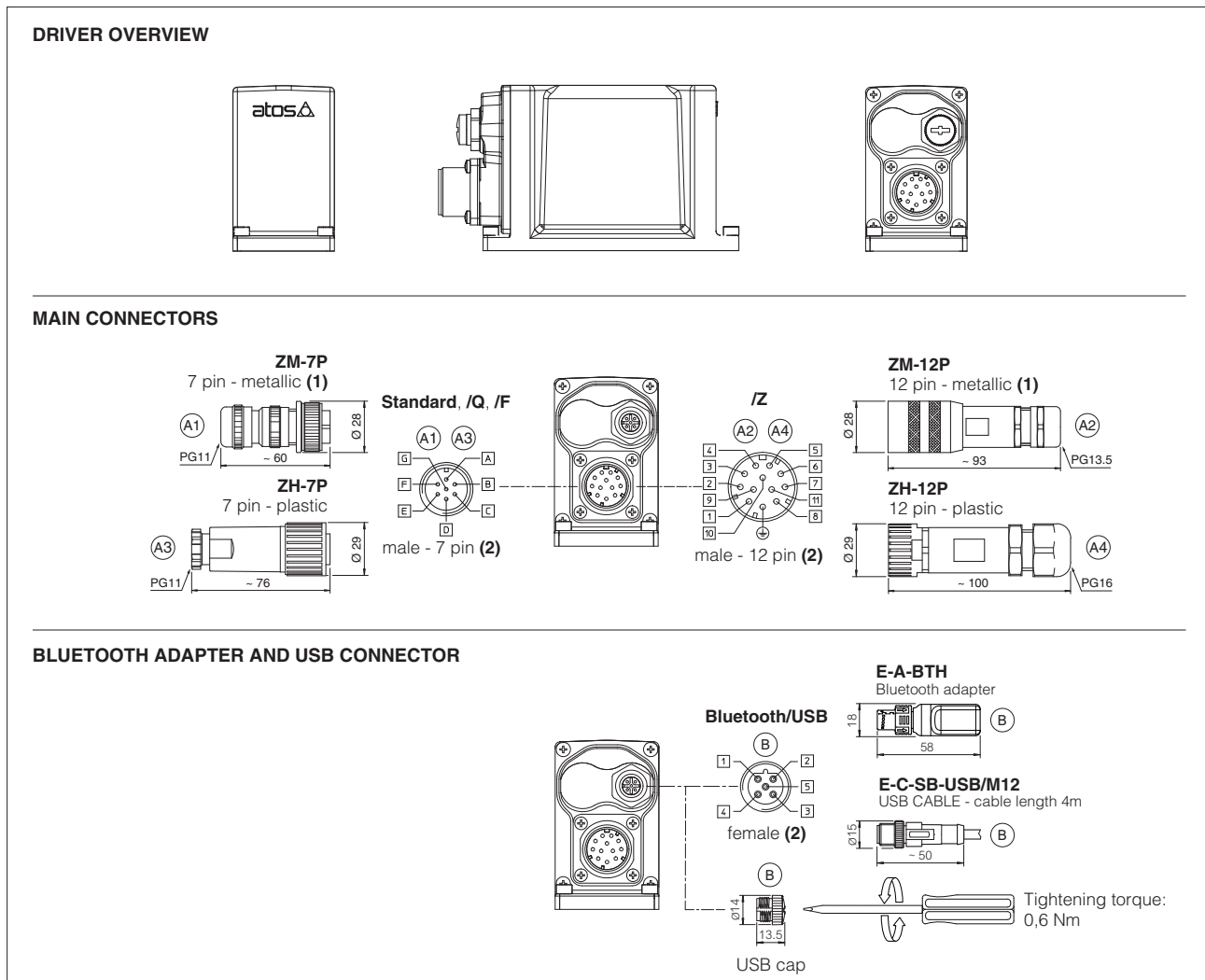

(1) Use of metallic connectors is strongly recommended in order to fulfill EMC requirements (2) Pin layout always referred to driver's view

22.7 TEB-SN-IL connections layout

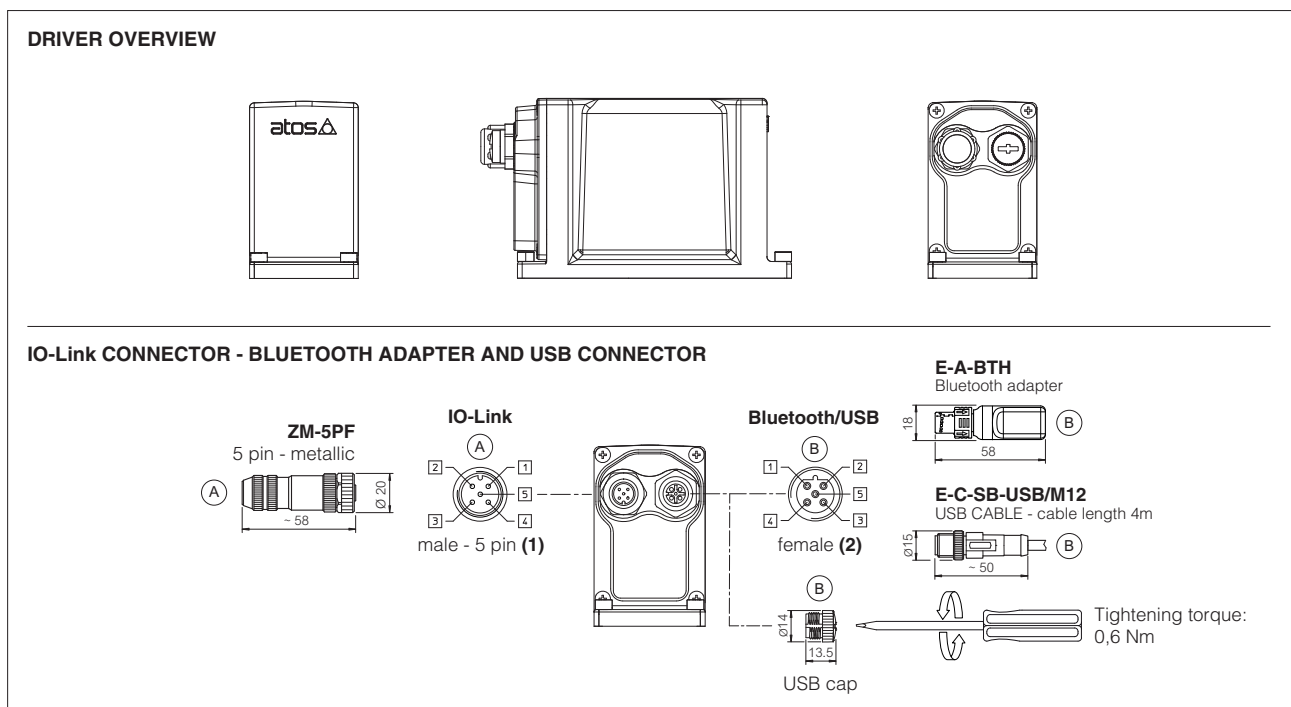

(1) Pin layout always referred to driver's view

22.8 TES connections layout

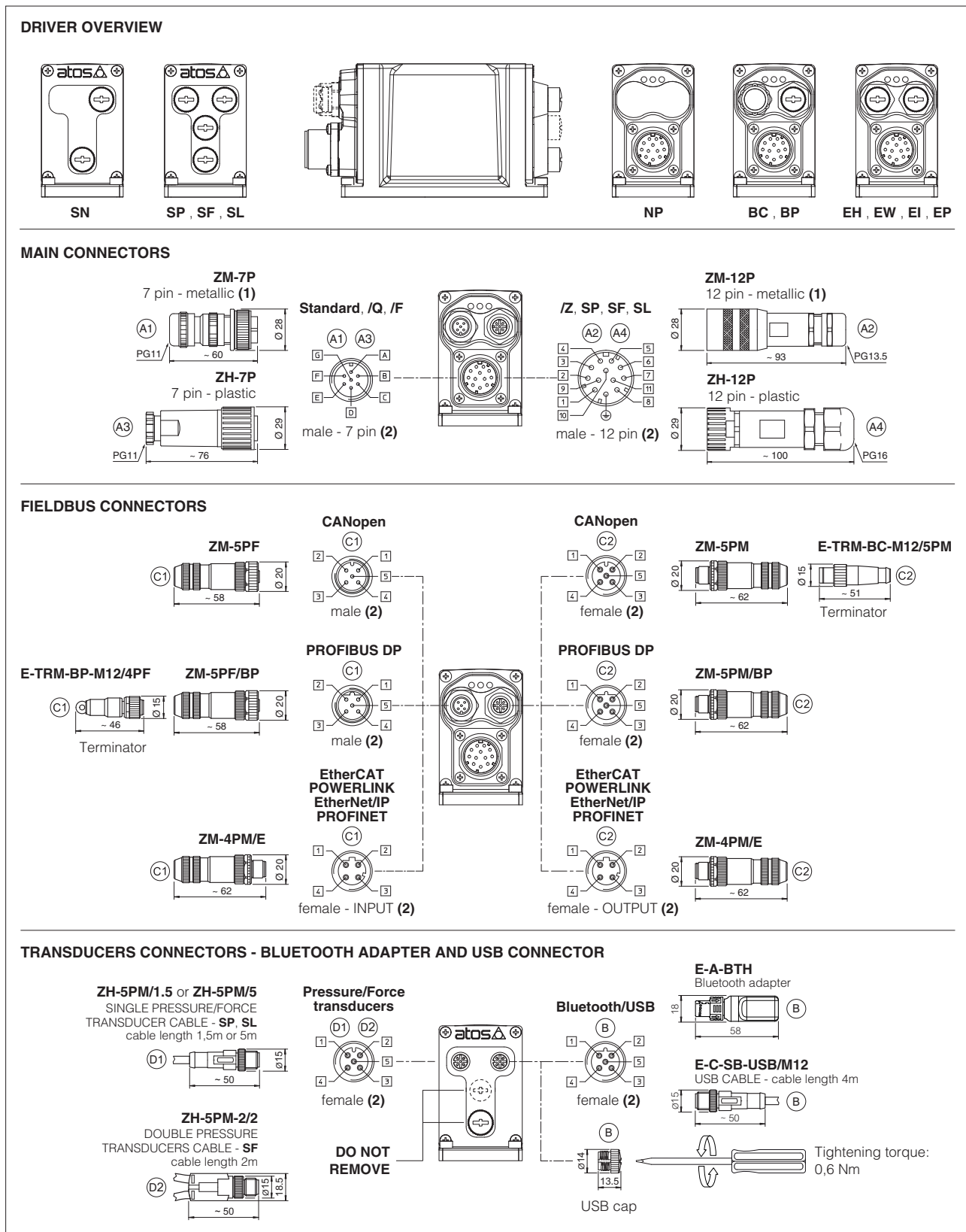

(1) Use of metallic connectors is strongly recommended in order to fulfill EMC requirements (2) Pin layout always referred to driver's view

22.9 Diagnostic LEDs - only for TES

Three leds show driver operative conditions for immediate basic diagnostics. Please refer to the driver user manual for detailed information.

FIELDBUS	NP	BC	BP	EH	EW	EI	EP	L1 L2 L3
LEDS	Not Present	CANopen	PROFIBUS DP	EtherCAT	POWERLINK	EtherNet/IP	PROFINET	
L1		VALVE STATUS			LINK/ACT			
L2		NETWORK STATUS			NETWORK STATUS			
L3		SOLENOID STATUS			LINK/ACT			

23 IN / OUT FIELDBUS COMMUNICATION CONNECTORS

Two fieldbus communication connectors are always available for digital drivers executions BC, BP, EH, EW, EI, EP. This features allows considerable technical advantages in terms of installation simplicity, wirings reduction and also avoid the usage expensive T-connectors.

For BC and BP executions the fieldbus connectors have an internal pass-through connection and can be used like end point of the fieldbus network, using an external terminator (see tech table **GS500**).

For EH, EW, EI and EP executions the external terminators are not required: each connector is internally terminated.

BC and BP pass-through connection

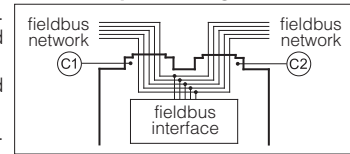

24 CONNECTORS CHARACTERISTICS - to be ordered separately

24.1 Main connectors - 7 pin

CONNECTOR TYPE	POWER SUPPLY AND SIGNALS	POWER SUPPLY AND SIGNALS
CODE	(A1) ZM-7P	(A3) ZH-7P
Type	7pin female straight circular	7pin female straight circular
Standard	According to MIL-C-5015	According to MIL-C-5015
Material	Metallic	Plastic reinforced with fiber glass
Cable gland	PG11	PG11
Recommended cable	LiYCY 7 x 0,75 mm ² max 20 m (logic and power supply) or LiYCY 7 x 1 mm ² max 40 m (logic and power supply)	LiYCY 7 x 0,75 mm ² max 20 m (logic and power supply) or LiYCY 7 x 1 mm ² max 40 m (logic and power supply)
Conductor size	up to 1 mm ² - available for 7 wires	up to 1 mm ² - available for 7 wires
Connection type	to solder	to solder
Protection (EN 60529)	IP 67	IP 67

24.2 Main connectors - 12 pin

CONNECTOR TYPE	POWER SUPPLY AND SIGNALS	POWER SUPPLY AND SIGNALS
CODE	(A2) ZM-12P	(A4) ZH-12P
Type	12pin female straight circular	12pin female straight circular
Standard	DIN 43651	DIN 43651
Material	Metallic	Plastic reinforced with fiber glass
Cable gland	PG13,5	PG16
Recommended cable	LiYCY 12 x 0,75 mm ² max 20 m (logic and power supply)	LiYCY 10 x 0,14mm ² max 40 m (logic) LiYY 3 x 1mm ² max 40 m (power supply)
Conductor size	0,5 mm ² to 1,5 mm ² - available for 12 wires	0,14 mm ² to 0,5 mm ² - available for 9 wires 0,5 mm ² to 1,5 mm ² - available for 3 wires
Connection type	to crimp	to crimp
Protection (EN 60529)	IP 67	IP 67

24.3 IO-Link connector - only for **TEB-SN-IL**

CONNECTOR TYPE	IL IO-Link
CODE	(A) ZM-5PF
Type	5pin female straight circular
Standard	M12 coding A - IEC 61076-2-101
Material	Metallic
Cable gland	Pressure nut - cable diameter 6÷8 mm
Recommended cable	5 x 0,75 mm ² max 20 m
Connection type	screw terminal
Protection (EN 60529)	IP 67

24.4 Fieldbus communication connectors

CONNECTOR TYPE	BC CANopen (1)		BP PROFIBUS DP (1)		EH EtherCAT, EW POWERLINK, EI EtherNet/IP, EP PROFINET (2)	
CODE	(C1) ZM-5PF	(C2) ZM-5PM	(C1) ZM-5PF/BP	(C2) ZM-5PM/BP	(C1) (C2) ZM-4PM/E	
Type	5 pin female straight circular	5 pin male straight circular	5 pin female straight circular	5 pin male straight circular	4 pin male straight circular	
Standard	M12 coding A - IEC 61076-2-101		M12 coding B - IEC 61076-2-101		M12 coding D - IEC 61076-2-101	
Material	Metallic		Metallic		Metallic	
Cable gland	Pressure nut - cable diameter 6÷8 mm		Pressure nut - cable diameter 6÷8 mm		Pressure nut - cable diameter 4÷8 mm	
Cable	CANbus Standard (DR 303-1)		PROFIBUS DP Standard		Ethernet standard CAT-5	
Connection type	screw terminal		screw terminal		terminal block	
Protection (EN 60529)	IP67		IP 67		IP 67	

(1) E-TRM-** terminators can be ordered separately - see tech table **GS500**

(2) Internally terminated

24.5 Remote pressure/Force transducer connectors - only for **SP, SF, SL**

CONNECTOR TYPE	SP, SL - Single transducer		SF - Double transducers
CODE	(D1) ZH-5PM/1.5	(D1) ZH-5PM/5	(D2) ZH-5PM-2/2
Type	5 pin male straight circular		4 pin male straight circular
Standard	M12 coding A - IEC 61076-2-101		M12 coding A - IEC 61076-2-101
Material	Plastic		Plastic
Cable gland	Connector moulded on cables 1,5 m length	5 m length	Connector moulded on cables 2 m length
Cable	5 x 0,25 mm ²		3 x 0,25 mm ² (both cables)
Connection type	molded cable		splitting cable
Protection (EN 60529)	IP 67		IP 67

DLHZO-TEB, DLHZO-TES

ISO 4401: 2005

Mounting surface: 4401-03-02-0-05 (see table P005)

(for /Y surface 4401-03-03-0-05 without X port)

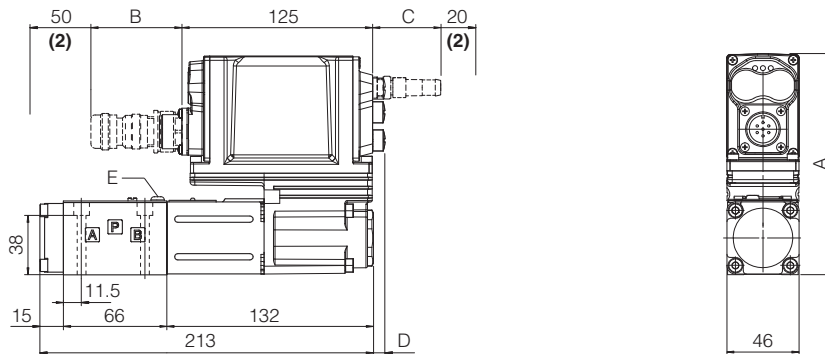

DLHZO	A	B (1)	C (1)	D	E (air bleeding)	Mass [kg]
TEB - SN - IL	140	60	-	-		2,7
TEB - SN - NP	140	100	-	-		
TES - SN - NP, BC, BP, EH	140	100	58	8		
TES - SN - EW, EI, EP	155	100	58	8		
TES - SP, SF, SL - *	155	100	58	8		

- (1) The indicated dimension refers to the longer connectors or Bluetooth adapter
For dimensions of connectors and Bluetooth adapter, see sections 22.6, 22.7 and 22.8
- (2) Space required for connection cable and for connector removal

DLKZOR-TEB, DLKZOR-TES

ISO 4401: 2005

Mounting surface: 4401-05-04-0-05 (see table P005)

(for /Y surface 4401-05-05-0-05 without X port)

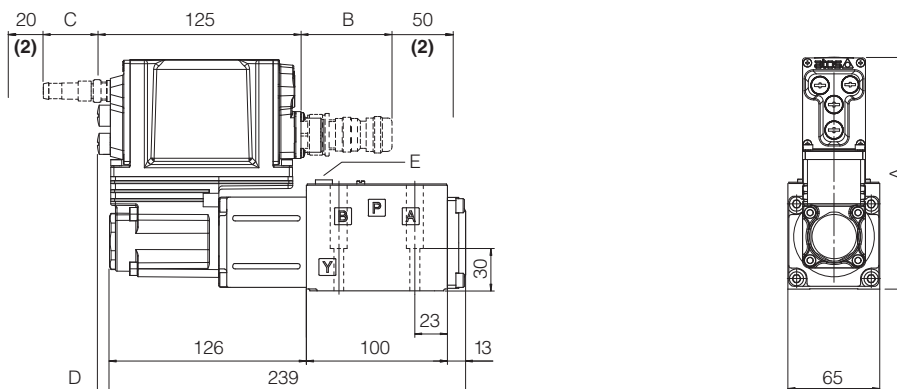



DLKZOR	A	B (1)	C (1)	D	E (air bleeding)	Mass [kg]
TEB - SN - IL	150	60	-	-		4,7
TEB - SN - NP	150	100	-	-		
TES - SN - NP, BC, BP, EH	150	100	58	8		
TES - SN - EW, EI, EP	165	100	58	8		
TES - SP, SF, SL - *	165	100	58	8		

- (1) The indicated dimension refers to the longer connectors or Bluetooth adapter
For dimensions of connectors and Bluetooth adapter, see sections 22.6, 22.7 and 22.8
- (2) Space required for connection cable and for connector removal

Note: for /B option the solenoid, the LVDT transducer and the on-board digital driver are at side of port A

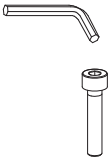
26 FASTENING BOLTS AND SEALS

	<p>DLHZO</p> <p>Fastening bolts: 4 socket head screws M5x50 class 12.9 Tightening torque = 8 Nm</p>	<p>DLKZOR</p> <p>Fastening bolts: 4 socket head screws M6x40 class 12.9 Tightening torque = 15 Nm</p>
	<p>Seals: 4 OR 108 Diameter of ports A, B, P, T: \varnothing 7,5 mm (max) 1 OR 2025 Diameter of port Y: \varnothing = 3,2 mm (only for /Y option)</p>	<p>Seals: 5 OR 2050 Diameter of ports A, B, P, T: \varnothing 11,2 mm (max) 1 OR 108 Diameter of port Y: \varnothing = 5 mm (only for /Y option)</p>

27 RELATED DOCUMENTATION

<p>FS001 Basics for digital electrohydraulics FS500 Digital proportional valves with p/Q control FS610 Digital proportional valves with integral axis controller FS900 Operating and maintenance information for proportional valves FY100 Safety proportional valves - option /U FY200 Safety proportional valves - option /K GS500 Programming tools GS510 Fieldbus GS520 IO-Link interface</p>	<p>K800 Electric and electronic connectors P005 Mounting surfaces for electrohydraulic valves QB300 Quickstart for TEB valves commissioning QF300 Quickstart for TES valves commissioning Y010 Basics for safety components E-MAN-RI-LEB TEB/LEB user manual E-MAN-RI-LES TES/LES user manual E-MAN-RI-LES-S TES/LES with p/Q control user manual</p>
--	--